

Wir rechnen mit dem Euro



Übersicht über alle Münzen Cent und Euro



		1 ct	0,01 €
		2 ct	0,02 €
		5 ct	0,05 €
		10 ct	0,10 €
		20 ct	0,20 €
		50 ct	0,50 €
		1 €	1,00 €
		2 €	2,00 €

Wir rechnen mit dem Euro





Schreibe immer als Centbetrag und als Eurobetrag! (Bis auf zwei Aufgaben!)

Beispiel:

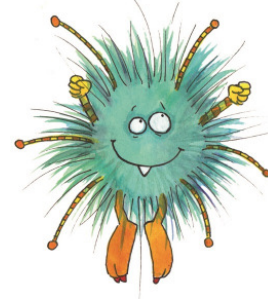

18 ct
0,18 €







_____ ct
_____ €



_____ ct
_____ €



_____ ct
_____ €



_____ ct
_____ €



_____ ct
_____ €



_____ ct
_____ €



_____ €



_____ €

Wir rechnen mit dem Euro



Schreibe immer als Centbetrag und als Eurobetrag! (Bis auf zwei Aufgaben!)

Beispiel:



18 ct
0,18 €







_____ ct
_____ €



_____ ct
_____ €



_____ ct
_____ €



_____ ct
_____ €



_____ ct
_____ €



_____ ct
_____ €



_____ €



_____ €

Wir rechnen mit dem Euro



Schreibe immer als Centbetrag und als Eurobetrag! (Bis auf zwei Aufgaben!)

Beispiel:



18 ct
0,18 €







_____ ct
_____ €



_____ ct
_____ €



_____ ct
_____ €



_____ ct
_____ €



_____ ct
_____ €



_____ ct
_____ €



_____ €



_____ €

Wir rechnen mit dem Euro



Schreibe immer als Centbetrag und als Eurobetrag! (Bis auf zwei Aufgaben!)

Beispiel:



18 ct
0,18 €







_____ ct
_____ €



_____ ct
_____ €



_____ ct
_____ €



_____ ct
_____ €



_____ ct
_____ €



_____ ct
_____ €



_____ €



_____ €

Wir rechnen mit dem Euro



Schreibe immer als Centbetrag und als Eurobetrag! (Bis auf zwei Aufgaben!)

Beispiel:



18 ct
0,18 €







_____ ct
_____ €



_____ ct
_____ €



_____ ct
_____ €



_____ ct
_____ €



_____ ct
_____ €



_____ ct
_____ €



_____ €



_____ €

Wir rechnen mit dem Euro





Schreibe immer als Centbetrag und als Eurobetrag! (Bis auf drei Aufgaben!)
 (Achtung: bei einer Aufgabe passiert etwas Neues!)

Beispiel:

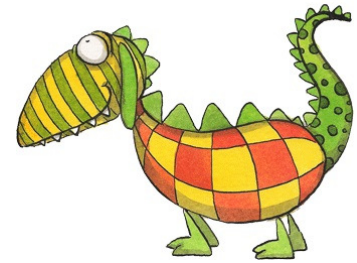

18 ct
0,18 €







_____ ct
_____ €



_____ ct
_____ €



_____ ct
_____ €



_____ ct
_____ €



_____ ct
_____ €



_____ €



_____ €



_____ €

Wir rechnen mit dem Euro



Schreibe immer als Eurobetrag!

Beispiel:

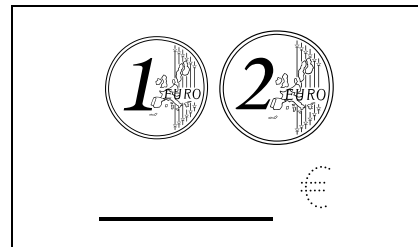
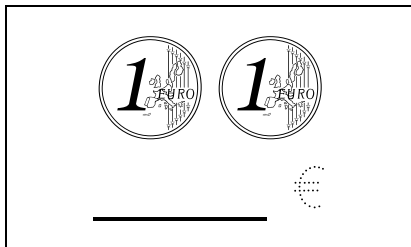
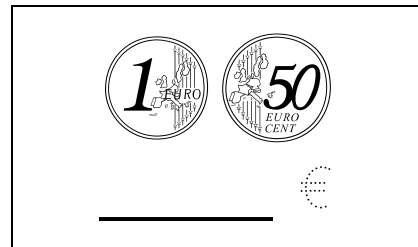
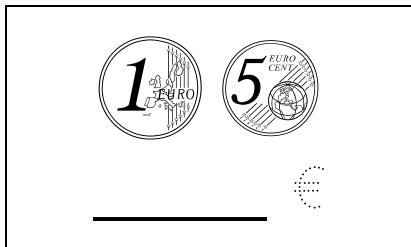
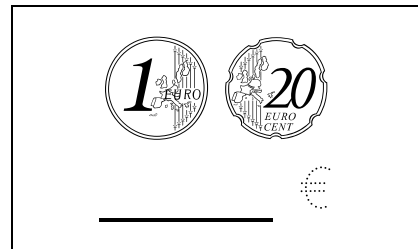
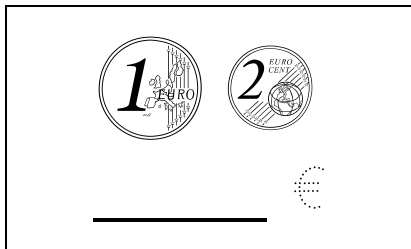
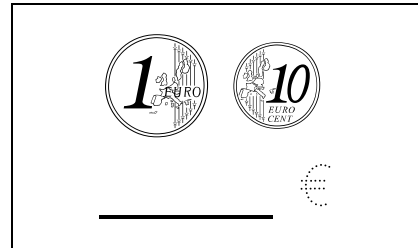
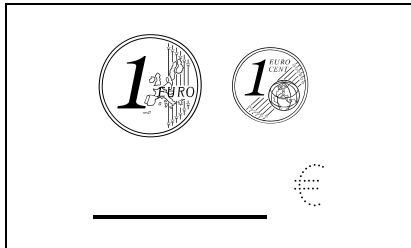
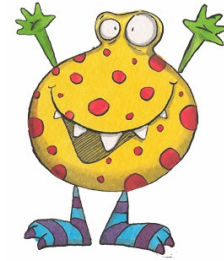

Wir rechnen mit dem Euro





Schreibe immer als Eurobetrag!

Beispiel:



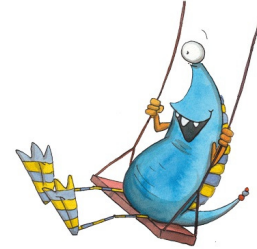

1,01 €





€



€

€





€



€



€

€

€
